

## **Appendix VI**

### **Imaging sonar review for marine environmental monitoring around tidal turbines**

# Imaging sonar review for marine environmental monitoring around tidal turbines

Report for OERA/FORCE, Pathway 2020

June 14, 2019

James Joslin, PhD  
Applied Physics Laboratory  
University of Washington  
1013 NE 40<sup>th</sup> Street, Seattle, WA 98105  
e-mail: [jbjoslin@uw.edu](mailto:jbjoslin@uw.edu)

## I. Introduction

Environmental monitoring of tidal turbines can provide valuable information on interactions between devices and marine animals that is necessary for the sustainable development of this resource. Information from early turbine deployments can help inform environmental impact assessments and mitigate risks for larger future deployments. Collecting and interpreting useful information from these high energy environments however poses many challenges to underwater instrumentation and data processing. Of the efforts to perform this type of monitoring over the last decade there have been a higher number of instrumentation or data collection failures than projects that succeeded in their monitoring goals. For future monitoring projects at these sites to be successful, lessons must be taken from previous efforts and experience from successful projects is invaluable.

In anticipation of upcoming turbine deployments in the Minas Passage, Bay of Fundy, the Offshore Energy Research Association (OERA) and the Fundy Ocean Research Center for Energy (FORCE) have put together the 'Pathway Program' to establish a suite of integrated environmental monitoring sensors for monitoring bottom-deployed turbines and floating tidal energy platforms. The first phase of this program involves a comprehensive literature review for different instrument classes that may be incorporated in the final monitoring solution. This review of imaging (or multibeam) sonars is an attempt to summarize the capabilities of these instruments for monitoring tidal turbines and the lessons learned from previous efforts. By assembling this information during this Phase, the 'Pathway Program' will reduce the development timeline and increase the capabilities of the integrated instrumentation suite.

For environmental monitoring at tidal energy sites imaging sonars can offer high resolution imagery in turbid waters without the need for artificial illumination. There are currently more than a dozen commercially available imaging sonars that have been developed for use in high energy marine environments. Each of these instruments varies in functional range, resolution, field of view, and mechanical configuration. The most typical applications of these sonars is for underwater vehicle navigation and situational awareness. Due to the nature of most use cases, not all sonars have been designed for long term deployments without regular maintenance. Similarly, most use cases do not require the sonar control software to be integrated on a multi-instrument platform with other active acoustics. For these reasons, many of the commercially available sonars are not well suited for monitoring tidal turbines and the best options are those that have been demonstrated on previous projects.

Acoustic imagery from these sonars has many advantages over optical imagery although classification of targets is generally more difficult. Data processing techniques are currently under development to allow real-time target detection, tracking, and, ultimately, classification. However, every monitoring project varies in environmental conditions and instrument configuration, thus requiring tuning of target detection algorithms. The final classification step of targets generally requires information from a secondary sensor, such as optical camera, an echosounder, or an ADCP.

This report presents a summary of the literature review followed by an overview of the most relevant commercially available imaging sonars. Section IV provides a summary of six applications of imaging sonars for similar use cases. Sections V and VI discuss key considerations for the integration of the sonar into the instrument platform and lessons learned from previous deployments. Finally the

report concludes with the best-in-class recommendations and a list of the references used in the literature review.

## II. Literature Review Summary

The use of imaging sonars for environmental monitoring in high current environments is documented in the literature by approximately 20 different relevant journal publications and project reports. These publications are spread across a range of applications that may be categorized by the deployment type, duration, target monitoring goals, and methods of data acquisition and processing. The three main categories for deployment methods are downward looking from a surface vessel, on a purpose built bottom lander, or integrated into the turbine structure. Depending on the deployment configuration, these monitoring projects typically last from less than one day up to several months. The monitoring goals for each project are often defined by regulatory requirements or project developer's interest in retiring perceived risks. To date, most monitoring projects have continuously acquired data throughout the deployment and used a combination of manual review and automated processing in post. Section IV of this report provides further details on 6 of the most relevant application of imaging sonars for tidal turbine monitoring along with the references for each case.

While the documentation of applications in the literature presents many of the best methods for using imaging sonars, many of the key considerations for successful integration and lessons learned from previous projects come from failures, which often remain undocumented. The most common of these challenges lie in the durability of the instruments for long term deployments and in the software for data collection and processing. All too many monitoring projects have either failed outright or been terminated early because of instrument failure and prohibitively high maintenance costs. In many cases, choosing the optimal instrument settings for data acquisition is not possible prior to deployment. Similarly, development of data processing software is not possible until the data is available. For these reasons, much of the data collected to date is either of low value or remains unprocessed. In an attempt to prevent such issues, this report presents key considerations and lessons learned from previous deployments that are both found in the literature and from the author's personal experience.

## III. Imaging Sonars

For this review, 18 different commercially available imaging sonars from 10 developers are summarized in the technology assessment rubric. Specifications for each sonar may be found in the instrumentation manual and used to assess the instruments suitability for monitoring tidal turbines. Given that every monitoring project has distinct requirement, which may change over the course of the project, the best sonar for each application will also vary. In addition to the general specification, manufacturers typically list common applications of their instruments which indicate their primary target markets. More information on the applications of these sonars for turbine monitoring are found in publications from each project.

### a. General Specifications for Turbine Monitoring

The specifications summarized in the technology assessment rubric were selected because they have the greatest impact on the monitoring capabilities of each imaging sonar. Table 1 provides a summary of these specifications for the 6 most relevant sonar producers. These specifications include the operating frequency, field of view or swath angles, functional range, I/O trigger option, and software

development kit (SDK) option. In general, the functional range of the sonar is determined by the operational frequency and the field of view and resolution are a function of the number of beams. The options for an input trigger or SDK are critical for instrument integration on a multi-instrument platform and for software customization. Finally, specific applications of each sonar are presented for reference.

*Table 1 - Summary table of most relevant imaging sonars with general specifications*

Sonar	Frequency	FOV	Range	Trigger	SDK?	Applications
Tritech Gemini	720 kHz	120 x 20 deg	<120 m	Yes	Yes	Vessel surveys, SeaGen, AMP
Teledyne BlueView	900/2250 kHz	130 x 20 deg	<100 / <10 m	Yes	Yes	AMP, vessel surveys
Kongsberg Mesotech	500 kHz	120 x 3, 7, 15, or 30 deg	<150 m	Yes	No	AMP, vessel surveys
Blueprint Subsea Oculus	375 or 750/1200 or 1200/2100 kHz	130 x 20 deg or 70 x 12 deg or 60 x 12 deg	<200 or <120 / <40 or <30 / <10 m	Yes	Yes	Vessel surveys
Imagenex Delta T	260 kHz	120 x 10 deg	<150 m	Yes	Yes	FLOWBEC
Sound Metrics Aris	1200/700 or 1800/1100 or 3000/1800 kHz	28 x 14 deg or 28 x 14 deg or 30 x 15 deg	<80 / <35 or <35 / <15 or <15 / <5 m	No	No	ORPC, Verdant RITE

#### IV. Previous Applications

While imaging sonars are a common tool for marine operations with many broad applications, there are relatively few applications that are relevant to tidal turbine monitoring. The following sections present summaries of 6 applications that are described in the literature and have the highest relevance to this program.

##### a. Vessel Surveys

Mounting imaging sonars on a pole over the side of a surface vessel is a common method for conducting bathymetry or marine life surveys (Melvin and Cochrane, 2015, Parsons et al., 2014 and 2017, ORPC Maine 2014, Grippo et al., 2017). Figure 1 shows the sonar configuration and vertical field of view and Figure 2 shows sample data for such a survey from Parsons et al. 2017. This study was performed with a Tritech Gemini sonar using the native software for data acquisition and processing. Similar surveys have also been conducted using the sonar in conjunction with a fisheries echosounder.

This combinations allows for fish classification with the echosounder and then tracking with the imaging sonar when targets can be co-registered between the two data streams. Advantages of this type of survey include the ability to cover a large area and the motion of the sonar can allow for 3D reconstruction. The primary draw backs of vessel surveys are the sort duration of operations and that the constantly changing field of view complicates background subtraction for automated data processing. The short duration of deployments does simplify sonar maintenance and allow for continuous data collection, eliminating the need for real-time target detection and tracking algorithms.

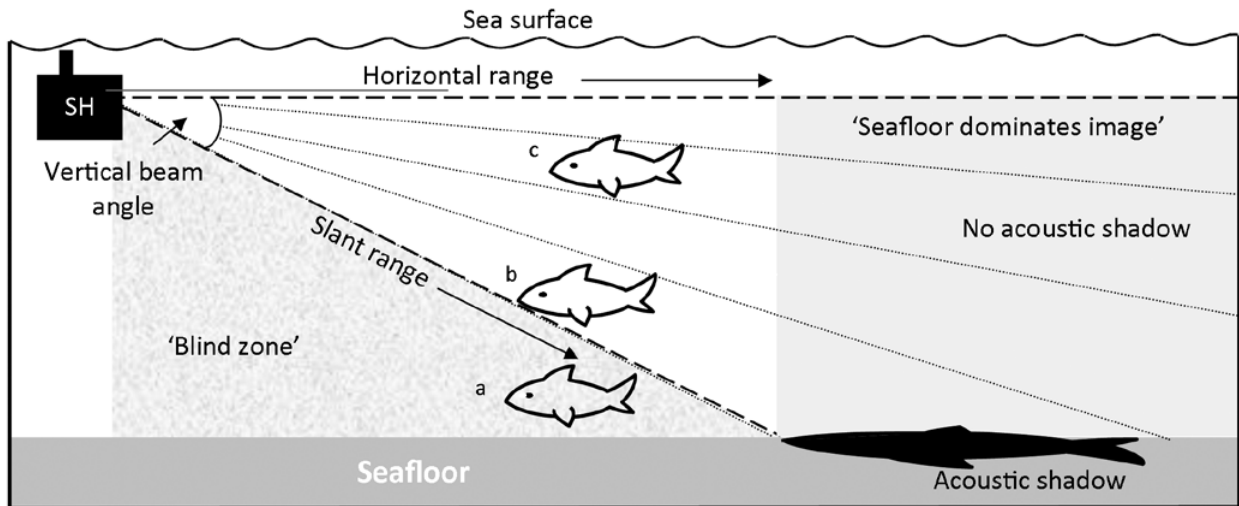
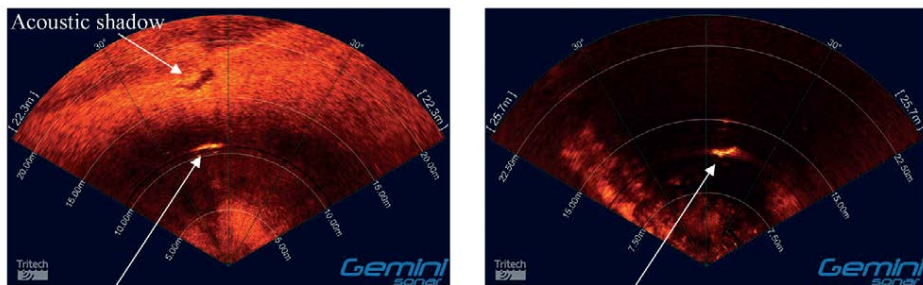

Figure 1 - Example of vessel based sonar configuration from Parsons et al. 2014



2.7 m Great White at 11m in 7.5 m of water 2.7 m Great White at 11 m in 15 m of water

Figure 2 - Example data from survey to track sharks in Australia from Parsons et al. 2014

### b. FLOWBEC-4D Platform

The FLOW, Water column and Benthic Ecology-4D platform (FLOWBEC-4D) is used by researchers in the UK for monitoring at tidal and wave energy sites (Williamson et al., 2016 and 2017). This system, shown in Figure 3, integrates the Imaginex 837A Delta T imaging sonar with the EK60 multi-frequency echosounder, an ADV, and a fluorometer with a large battery bank for autonomous deployments. Figure 4 shows an example of a processed data sequence with the imaging sonar and echosounder tracking biological targets on the approach of a tidal turbine. The battery bank is sized to allow for continuous data collection for 2 week deployments with rapid 1 day turnarounds to span the full neap tidal cycles. Deployment and recovery of this platform has been demonstrated to place the package within 50 m of

the tidal turbine structure. The deployments to date have allowed for target detection and tracking algorithm development to simplify post processing of the data collected.

The Imaginex 837A Delta T sonar was originally selected for this platform due to previous in-house experience with the sonar, relatively low instrument cost, and low power draw and data bandwidth. The previous in-house experience simplified the integration of the sonar into the platform and ensured synchronization with the EK60 echosounder. The low power and bandwidth requirements similarly made this sonar better suited to the autonomous battery powered platform. The mounting of the sonar on the platform provides a field of view that allows for target co-registration with the echosounder and tracking up to the turbine structure. The narrow angle of the swaths of both the sonar and echosounders, however, result in a narrow horizontal area of the turbine being monitored.



Figure 3 - FLOWBEC platform during deployment at EMEC from Williamson et al. 2017.

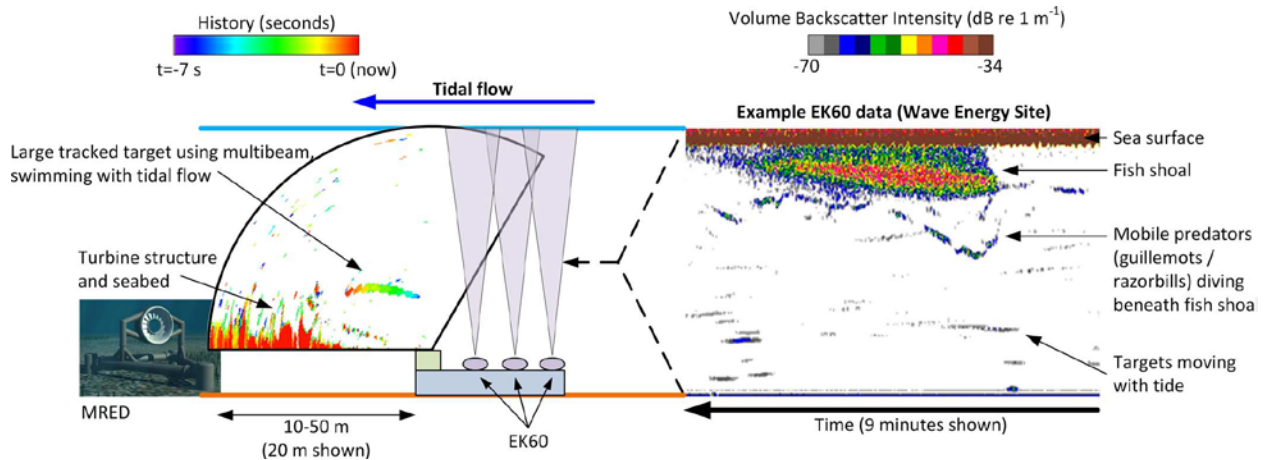

Figure 4 - Example data from FLOWBEC deployment from Williamson et al. 2017.

### c. SeaGen, Strangford Lough

Harbor seal and porpoise monitoring for the SeaGen turbines in Strangford Lough is the longest duration environmental monitoring program with imaging sonars (G. Hastie, 2013). For this project, a Tritech Gemini sonar was integrated with the turbine structure as shown in Figures 5 and 6. Throughout the turbine operations, if harbor seals or porpoises were detected close to the turbines operations were shut down to avoid potential blade strikes although no such interactions were ever detected. This

monitoring project represented the first of its kind to use an imaging sonar and allowed Trittech to implement autonomous real time target detection and tracking algorithms in their software.

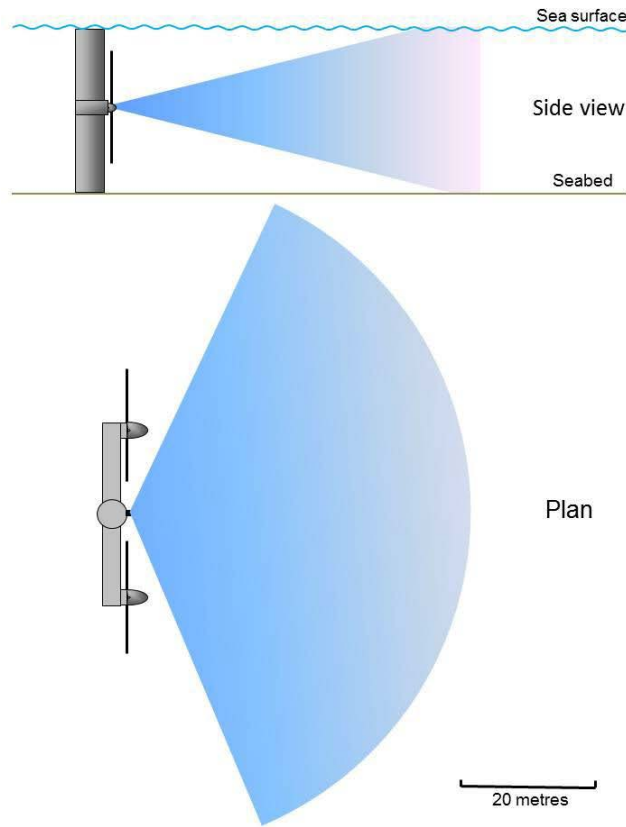

Figure 5 - Sonar configuration on SeaGen turbines from Hastie, 2013.



Figure 6 – SeaGen Turbines in Strangford Lough and example imagery of a seal at 10 m from Hastie, 2013.

d. ORPC, Cobscook Bay

Ocean Renewable Power Company (ORPC) has performed extensive monitoring for all of their turbine deployments to date. In 2012, two Sound Metrics DIDSON imaging sonars were used on their turbine test platform to monitor for fish passage through or around their turbine (Viehman et al., 2014).



Figure 7 shows the sonar configuration from the vessel-based test platform looking down and through the turbine in both fore and aft positions. Figure 8 shows an example of annotated data from the deployment with sample fish tracks. These DIDSON imaging sonars have the highest resolution of commercially available instruments which allows for individual fish tracking and classification. Conversely, these sonars have a narrow field of view and short range compared to most others. For this application data was collected continuously for 22 hours with manual post processing. Additional vessel based surveys for fish abundance using echosounders around ORPC turbines in Cobscook Bay are described in Grippo et al., 2017.

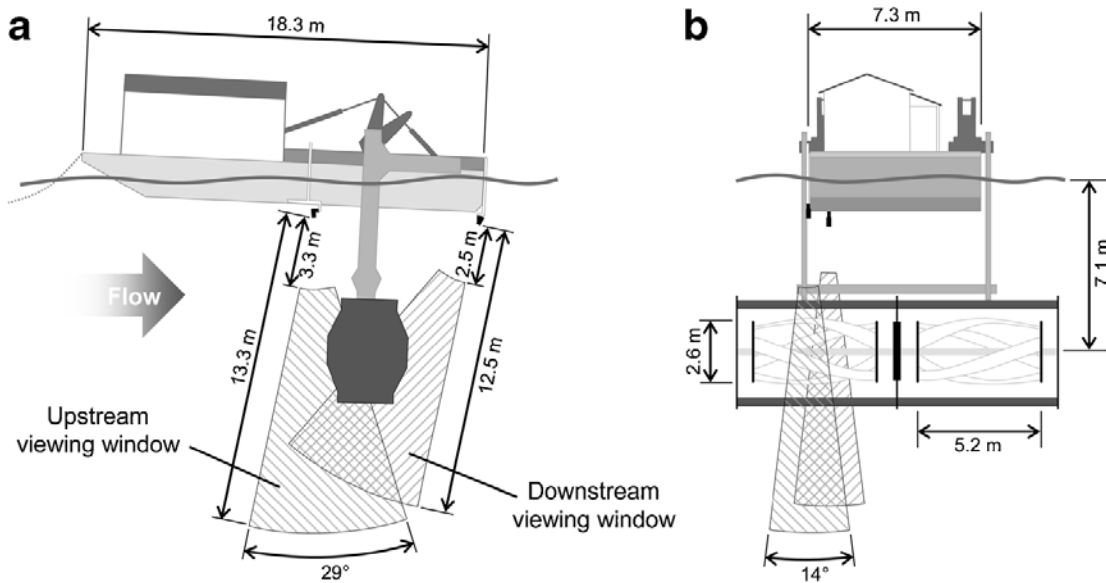

Figure 7 - Sonar configurations on ORPC turbine test platform from Viehman et al., 2014.

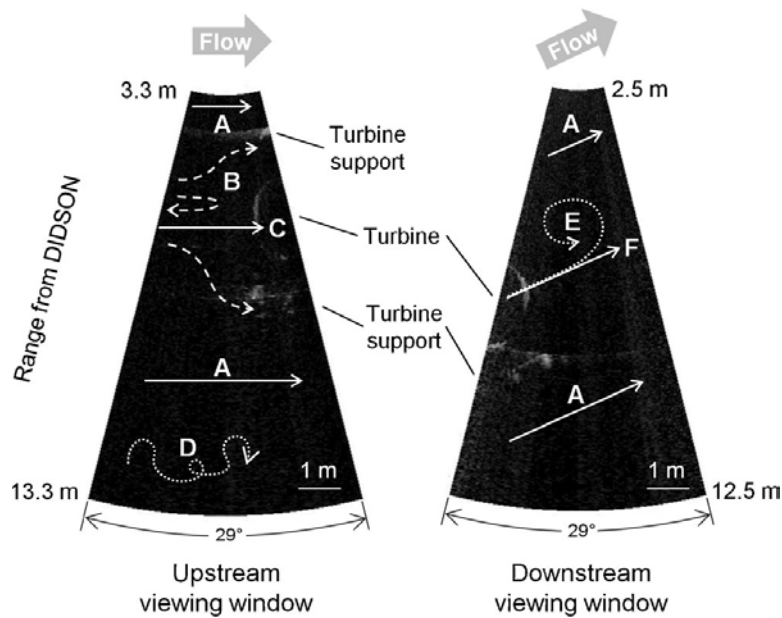

Figure 8 - Example of annotated data with fish passage from Viehman et al., 2014.

e. Verdant, RITE Project

The tidal turbine deployment for the Verdant RITE project incorporated a Sound Metrics DIDSON camera on a standalone bottom mounted platform approximately 12 m from the turbine base (Bevelhimer et al., 2016). For this application the sonar was mounted on a pan and tilt platform to allow the field of view to be aimed throughout the deployment as shown in Figure 9. The monitoring objective of the sonar was to observe fish behavior relative to the turbine and look for avoidance. Although the turbine itself failed after the first few days of the deployment, the sonar continued to collect data continuously for 19 days. The data processing effort was led by Oak Ridge National Laboratory and evaluated autonomous processing algorithms for fish detection and tracking.

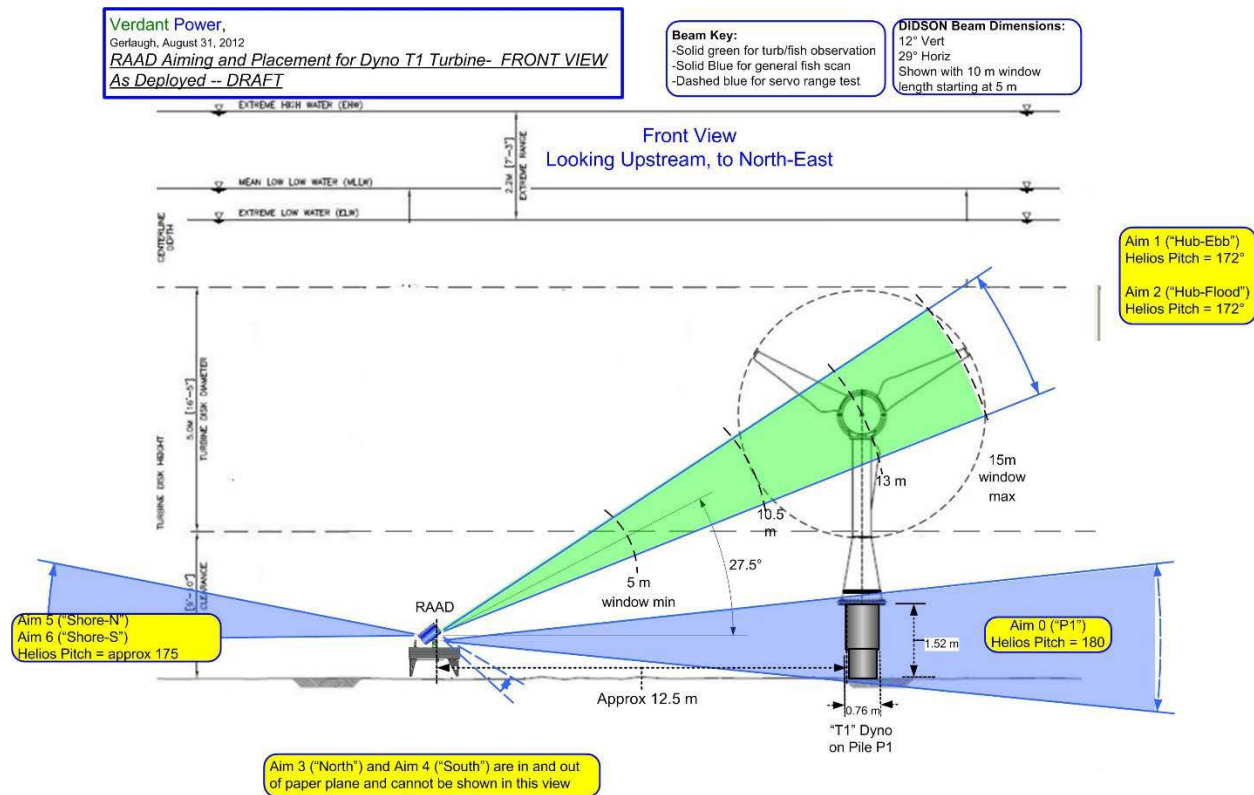

Figure 9 - Deployment configuration of sonar and turbine for Verdant RITE project from Bevelhimer et al., 2016.

f. AMP Platform

The Adaptable Monitoring Package (AMP) is an integrated instrumentation platform under development at the University of Washington since 2011 for environmental monitoring at tidal energy sites (Cotter et al., 2017). The most recent deployment of the AMP, shown in Figure 10, was at the Pacific Northwest National Labs Marine Science Laboratory in Sequim Bay, Washington from January to May 2019. This system integrates a Tritech Gemini sonar, a BlueView sonar, a WBTmini splitbeam echosounder, stereo optical cameras with strobe lights, and ADCP, four icListen hydrophones, a Vemco fishtag receiver, a water clarity sensor, antifouling wipers and UV lights, an inertial measurement sensor, and a tilt motor for the instrument head. This system integrates both the Gemini and BlueView sonars to take advantage of the long and short relative ranges of the two instruments. The objective of the deployment in Sequim bay was to evaluate the systems monitoring capabilities and improve real time target detection, tracking, and classification algorithms. Due to the high bandwidth of the sensors on the

AMP, imaging sonar data is processed in real time to detect targets of interest and trigger the optical camera lights and data archival. This real-time approach to initial data processing avoids data mortgages and simplifies any post processing steps required. Throughout this 135 day deployment the system was operational for 97% of the time and performed real time target detection, tracking, and triggering on schools of fish, seals, diving sea birds, and squid.

In addition to this Sequim Bay deployment, the AMP has been deployed in various configurations twice previously in Sequim Bay, off the coast of Newport, Oregon at the PacWave site, and in Kaneohe Bay, Hawaii at WETS for a total of over two years of in water testing. Due to the author's personal experience in the development of the AMP, many of the key considerations and lessons learned presented in Sections V and VI reference this system.



*Figure 10 - 3G-AMP prior to deployment in Sequim Bay, WA, Jan 2019.*

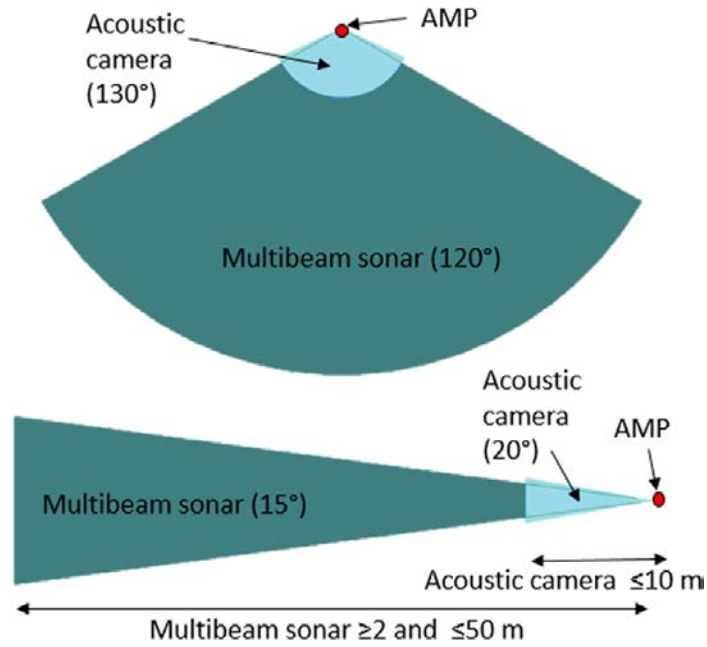

Figure 11 - Sonar configuration on the AMP from Cotter et al., 2017.

## V. Key Considerations for Use of Imaging Sonars for Turbine Monitoring

The successful integration of imaging sonars for tidal turbine monitoring relies on an understanding of the sonar operations and of the environmental conditions at the deployment site. Given the exceptionally strong currents in Minas Passage, the best suited instruments will be the most durable with demonstrated performance in similar conditions. The following sections presents an overview of some of the key considerations for integrating the sonar in a multi-instrument platform for this site.

### a. Mounting and Orientation

The ideal imaging sonar orientation depends heavily on the location and size of the turbine and the monitoring objectives. As evidence by the applications described in Section IV, the sonar swath may be oriented to look across the turbine, out in front of or behind the turbine, with a vertical or horizontal orientation, and either from a bottom or surface platform. Each configuration presents unique challenges and benefits that are difficult to predict prior to testing. If the monitoring objective is for individual fish passage, a high resolution sonar will need to be mounted in close proximity to the turbine. Alternatively, if the monitoring objective is to cover the full turbine area, a configuration such as shown in Figure 12 may be necessary.

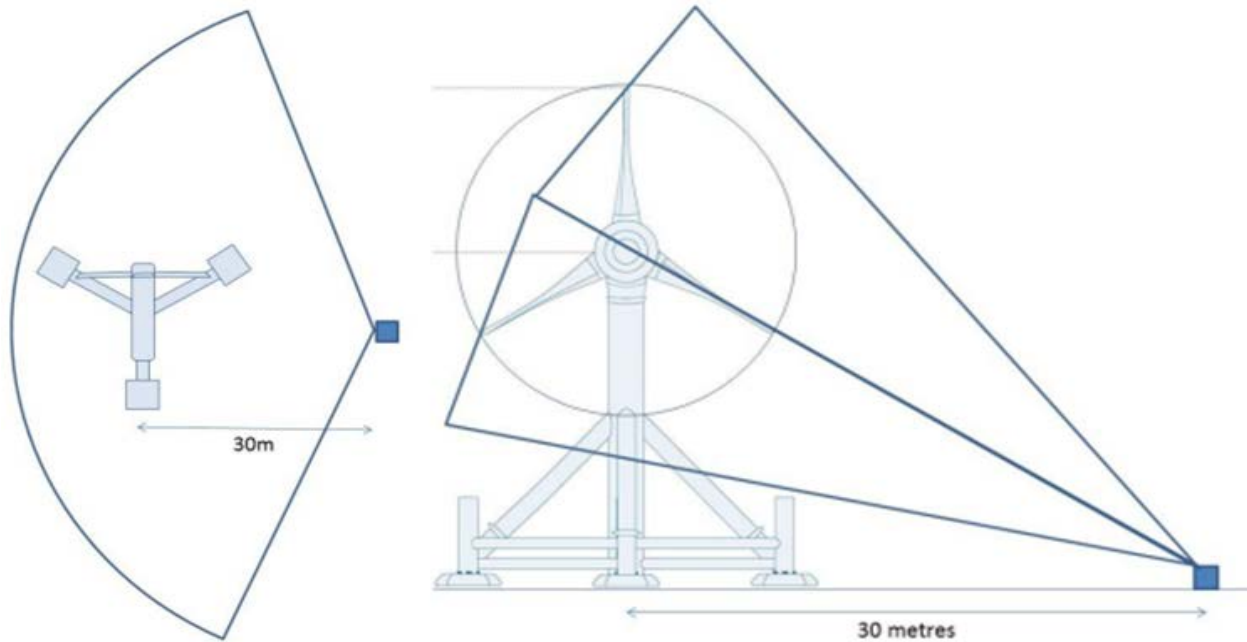

Figure 12 - Example of sonar orientation relative to turbines for Pentland Firth Meygen Project

#### b. Electrical and Communications Connections

The typical connections for imaging sonars provide the instrument power, use Ethernet communications protocols, and have optional I/O lines for triggering. On some sonars, the optional trigger input requires a second connector (Gemini and M3). In the case where two connectors are required, they may often be “wired” into a single cable for connection to a control bottle using a 13 pin power and Ethernet connector. For proper operation, the power supply and Ethernet connections should be optically isolated in the control bottle with relay control to power cycle the instrument. Prior to deployment, IP addresses should be established for each instrument to ensure proper network control and data transfer.

#### c. Software for Instrument Control and Data Acquisition

All instrument developers have custom software for controlling their sonar and acquiring data. In order to integrate multiple instruments on a single platform and optimize for monitoring performance, customization is required that is typically beyond the native software capabilities. For this reason, sonars with manufacturer supported SDKs are more suitable to platform integration. For the AMP, instrument control and data acquisition software has been developed using National Instruments LabView for both the BlueView and Gemini imaging sonars.

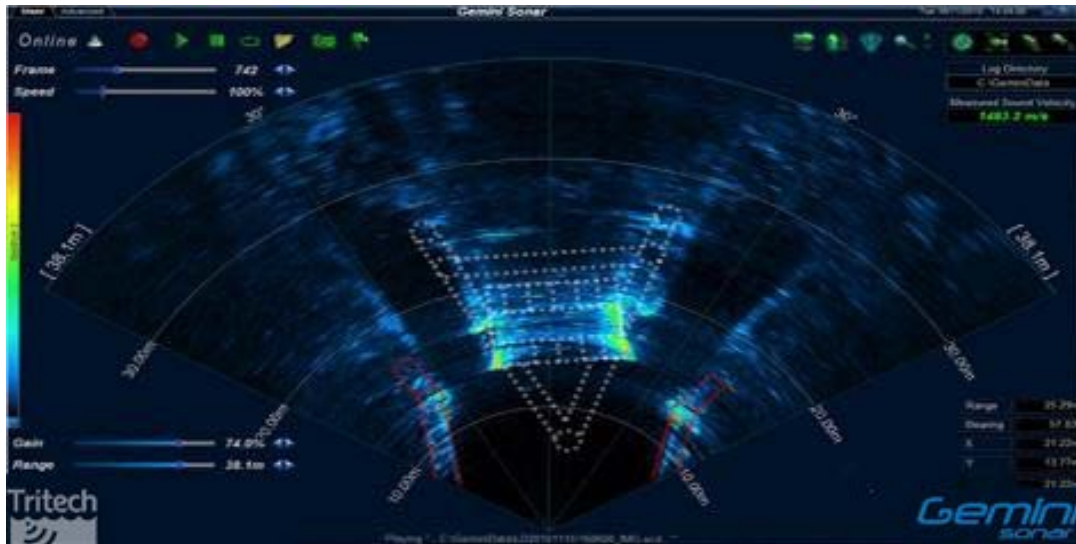

Figure 13 - Example screenshot from Tritech Seanet Pro software.

#### d. Software for Data Processing

The development of automatic data processing algorithms is an active area of research for most tidal turbine monitoring projects. The most recent publications on these methods have demonstrated the ability to detect and track targets with some ability to automatically classify between biologic and non-biologic classes. This classification level of processing typically relies on information from multiple instruments, such as shown in Figure 14, where the AMP targets from the imaging sonar could be classified by the optical imagery (Cotter et al., 2017). Implementation of data processing techniques should leverage previous efforts in this area to reduce processing and reporting timelines.

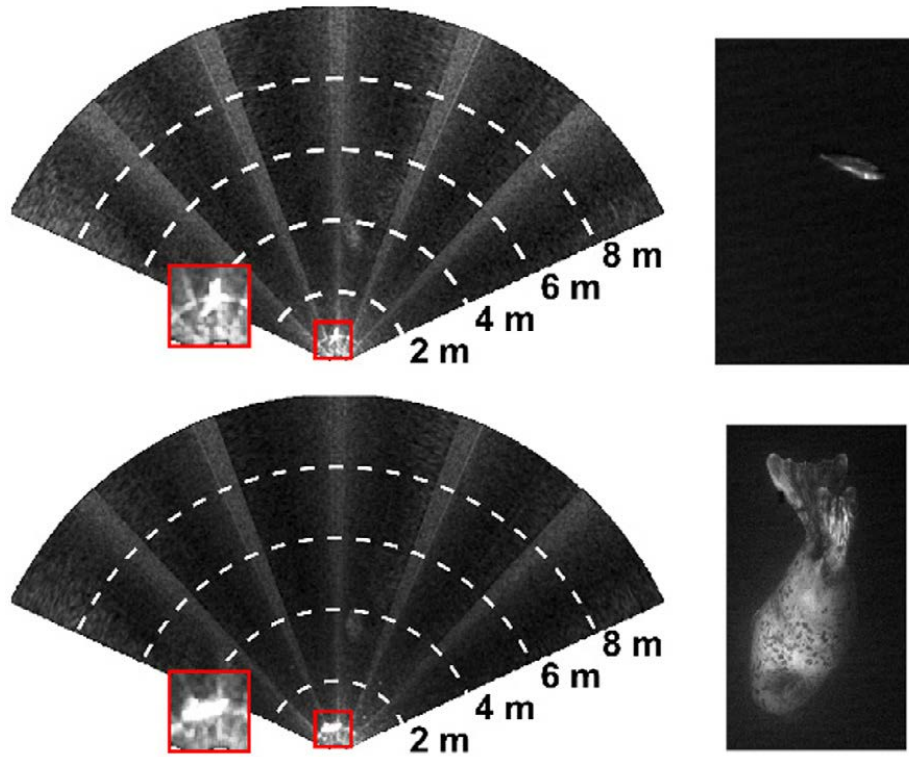

Figure 14 - Examples of AMP data of seal and fish detection and classification with optical cameras from Cotter et al., 2017.

## VI. Lessons Learned from Previous Applications

The following sections present some of the primary lessons learned from previous imaging sonar deployments. These examples are included in this report to help guide this programs development of its multi-instrument monitoring platform.

### e. Biofouling

Long term deployments of instrumentation in the marine environment are guaranteed to result in biofouling that will eventually inhibit data collection. While growth on sonar transducers does not inherently degrade the imagery, the growth can cause damage to sensitive components over time. Figure 15 shows examples of extreme biofouling from the most recent AMP deployment in Sequim Bay. In this case, the system was deployed in only 6 m of water for over 4 months through the most productive time of the year. The best solution to prevent biofouling is a regular maintenance interval that does not allow macro fouling to form. For the more sensitive components of instrumentation, such as optical view ports and transducers, biofouling wipers (ZibraTech Inc.) and UV lights (AML) are effective. Some transducer elements may also be coated with antifouling paint or high content zinc oxide paste. For less sensitive components of the platform, copper or vinyl tape may be used to coat surfaces to either inhibit growth or easily remove growth after recovery.



Figure 15 - Example of extreme biofouling from recent AMP deployment with UV lights on sonar transducers

#### f. Corrosion

Since the most typical applications of imaging sonars are for short term deployments, corrosion on the instrument or its connectors should be anticipated. Figure 8 shows examples of corrosion on an anodized aluminum housing and on the locking sleeves of a sonar's connectors from previous AMP deployments. Mitigation of this type of corrosion is best performed by the elimination of dissimilar metal contact and ground faults throughout the instrumentation package. If it is not possible to eliminate all dissimilar metal contact (for example, if you are delivered a sonar with a titanium housing and stainless steel connectors) a sacrificial anode should be added to prevent corrosion of sensitive components. For aluminum housings, a zinc anode may be used and for stainless steel housings, a mild steel anode may be better to limit the rate of the anode's corrosion.

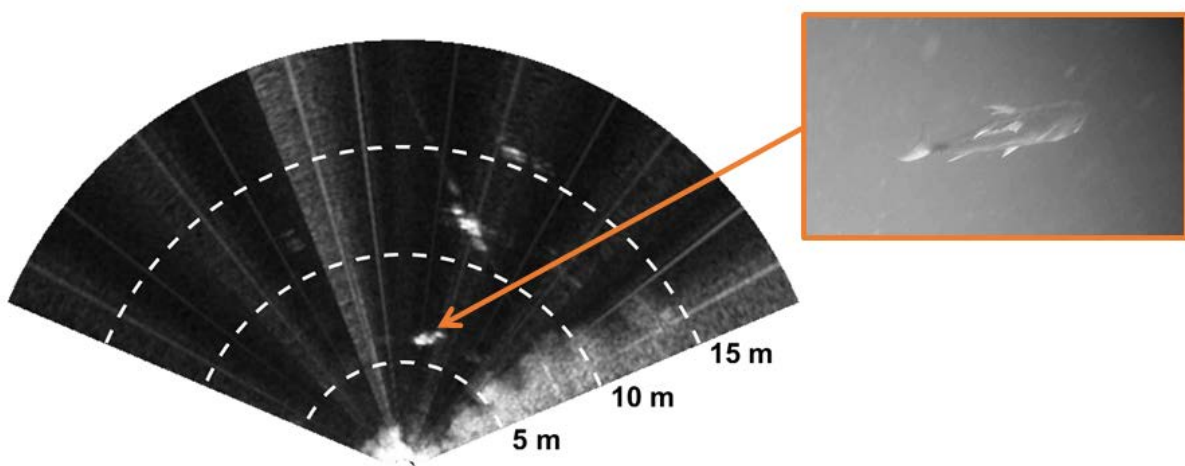

Figure 16 - Examples of corrosion on anodized aluminum housing and connectors with dissimilar metals



#### g. Image Noise from Acoustic and Electrical Interference

Sonar integration on a multi-instrument platform can result in interference from other active acoustic sources and electrical noise. Figure 17 shows an example of electrical interference on a BlueView sonar in the form of thin radial lines that only appeared when the strobe lights for the optical cameras were triggered. This type of interference is typically due to DC power converters that operate at frequencies similar to the imaging sonars. Changes in power output provided by these converters can produce noise in the sonar imagery. To avoid this type of noise, the power supplied to the sonar should be isolated and filtered. To avoid cross talk between active acoustic instruments, synchronization of the instrument controls is necessary to interweave pings. This type of control typically requires the sonar to have an input trigger option that can be synchronized with a central controller.



*Figure 17 - Example data from BlueView deployment where thin radial lines appear when strobe lights fire*

#### h. Image Noise from Environmental Conditions

High current sites often result in large turbulent vortices and bubble clouds or debris deep in the water column. These non-biological targets complicate environmental monitoring as they can mask actual targets of interest and impede automatic target detection algorithms. Similarly, moving targets in the sonar field of view (such as turbine blades or the water surface) or a sonar mounted to a moving platform, can result in large changing reflections in the sonar image. Figure 18 shows an example of multiple noise sources on a BlueView sonar mounted to a surface buoy. For these reasons, integration of the sonar on a bottom mounted platform that is within the waters depth to the side of the turbine will most likely result in the highest quality imagery (similar to the configuration in Figure 12).

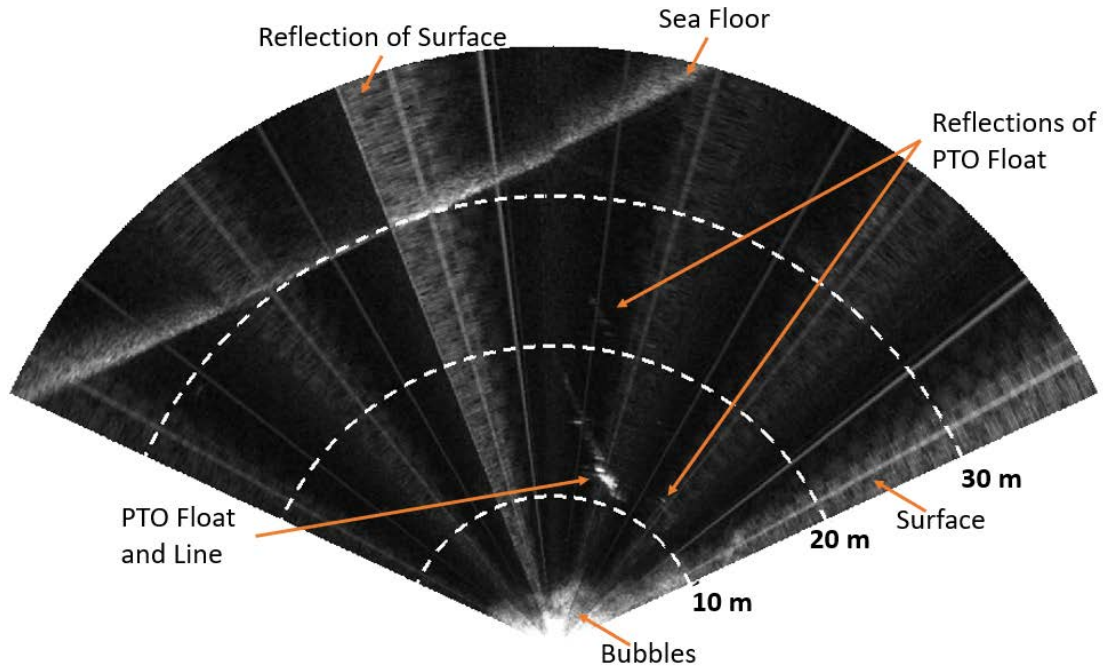

Figure 18 - Example data from BlueView deployment with multiple targets creating non-biologic triggers

i. Sonar Sound Levels

Another active area of research for turbine monitoring with imaging sonars is the marine animal response to the noise produced by the sonar. Although sonars operational frequencies are well above the hearing levels of marine animals, the sonars do typically produce some sound across all frequencies as shown in Figure 19. Due to this lower frequency sound, it is possible that marina animal behavior may be affected. While the sound levels are not typically high enough to be of concern, further research is needed in this area to fully classify behavioral changes that are detected by imaging sonars.

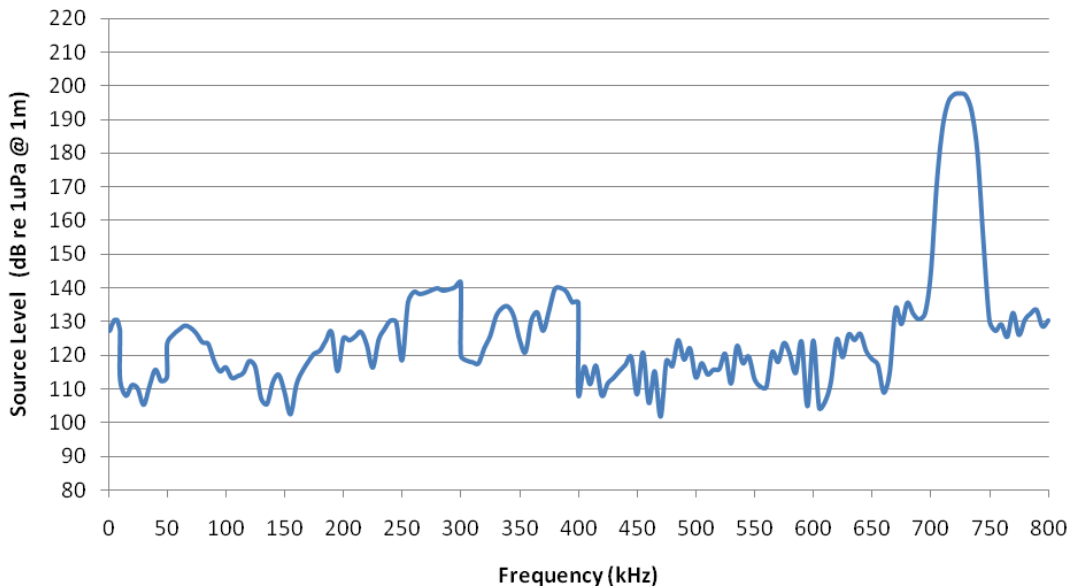

Figure 19 - Source level of Tritech Gemini from G. Hastie Report

## VII. Summary and Recommendations

This literature review shows that imaging sonars can be an effective tool for environmental monitoring of tidal turbines but successful application requires careful consideration of the integration methods. Previous efforts have successfully used imaging sonars on both bottom and surface mounted platforms to monitor for fish, seals, porpoises, and diving sea birds. Target classification from imaging sonars is best achieved by pairing the sonar data stream with optical cameras or fisheries echosounders. Although custom software development may be required for instrument control, data acquisition, and data processing, these tools can greatly decrease manual review and processing delays. The following sections presents an overview of the best-in-class recommendation and the application methods.

### j. Best-in-Class Sonar Recommendations

Commercially available imaging sonars that are best suited for tidal turbine monitoring in Minas Passage are the most robust and have had the most successful use cases. In addition, these sonars should offer both an optional input trigger line and SDK to be integrated on a multi-instrument platform with other active acoustics. For these reasons, the recommendation for the best-in-class imaging sonars is the Tritech Gemini 720is and the Teledyne BlueView M900/2250 as shown in Figure 20. These sonars have the broadest demonstrated use cases for tidal turbine monitoring with optional input triggers and SDKs. Depending on the range and resolution requirements of the monitoring objectives the benefits of each sonar will vary. The Gemini will be better suited for longer range application with lower resolution requirements while the BlueView will provide higher resolution at closer ranges. Although these sonars are recommended by this report, other monitoring objectives or prior in-house experience may dictate the preference for another instrument.



Figure 20 - Best-in-class imaging sonar recommendations, the Tritech Gemini 720is and the Teledyne BlueView M900/2250

### k. Application Recommendations

While every tidal turbine monitoring application is different, there are some universal recommendations that should be considered for the development of this platform. The first of these recommendations is that the monitoring objectives for the platform should be clearly outlined prior to system development to ensure the required capabilities are achieved. Second, the software integration and data processing options may drive the instrument selection process. Without the software in place to perform the data processing, long delays in acquiring useful information from the platform should be expected. Third, the mounting and deployment orientation will have a large impact on the image quality. For this reason it is important to design flexibility into the overall system to allow for alternative

instrument configurations. Forth, proper consideration should be given for electrical isolation, corrosion resistance, and biofouling mitigation to ensure long term performance of the platform. Finally, pre-deployment testing in similar environments with easier maintenance options is essential to avoid costly failures during critical deployments.

## VIII. References

- B. J. Williamson *et al.*, "A Self-Contained Subsea Platform for Acoustic Monitoring of the Environment Around Marine Renewable Energy Devices—Field Deployments at Wave and Tidal Energy Sites in Orkney, Scotland," in *IEEE Journal of Oceanic Engineering*, vol. 41, no. 1, pp. 67-81, Jan. 2016. doi: 10.1109/JOE.2015.2410851
- B. J. Williamson, S. Fraser, P. Blondel, P. S. Bell, J. J. Waggitt and B. E. Scott, "Multisensor Acoustic Tracking of Fish and Seabird Behavior Around Tidal Turbine Structures in Scotland," in *IEEE Journal of Oceanic Engineering*, vol. 42, no. 4, pp. 948-965, Oct. 2017. doi: 10.1109/JOE.2016.2637179
- Williamson, B.; Fraser, S.; Blondel, P.; Bell, P.; Waggitt, J.; Scott, B. (2016). Integrating a Multibeam and a Multifrequency Echosounder on the Flowbec Seabed Platform to Track Fish and Seabird Behavior around Tidal Turbine Structures. Paper Presented at the 4th Marine Energy Technology Symposium (METS), Washington DC, USA.
- Jha, S. (2016). Tidal Turbine Collision Detection: A review of the state-of-the-art sensors and imaging systems for detecting mammal collisions. Report by ORE Catapult. pp 50.
- Francisco, F.; Sundberg, J. (2019). Detection of Visual Signatures of Marine Mammals and Fish within Marine Renewable Energy Farms using Multibeam Imaging Sonar. *Journal of Marine Science and Engineering*, 7(1), 1-19.
- Verfuss, U.; Gillespie, D.; Gordon, J.; Marques, T.; Miller, B.; Plunkett, R.; Theriault, J.; Tollit, D.; Zitterbart, D.; Hubert, P.; Thomas, L. (2018). Comparing methods suitable for monitoring marine mammals in low visibility conditions during seismic surveys. *Marine Pollution Bulletin*, 126, 1-18.
- Giorli, G. (2017). Combining Passive Acoustics and Imaging Sonar Techniques to Study Sperm Whales' Foraging Strategies. *Journal of the Acoustical Society of America*, 142(3).
- Dual stacked Tritech Gemini vertical and horizontal swath (Sparling et al. 2016)
- Grippo, M.; Shen, H.; Zydlewski, G.; Rao, S.; Goodwin, A. (2017). Behavioral Responses of Fish to a Current-Based Hydrokinetic Turbine Under Multiple Operational Conditions: Final Report. Report by Argonne National Laboratory (ANL) and University of Maine. pp 49.
- Viehman, H. a., & Zydlewski, G. B. (2014). Fish Interactions with a commercial-scale tidal energy device in the natural environment. *Estuaries and Coasts*, 38(Suppl 1), S241–S252. <https://doi.org/10.1007/s12237-014-9767-8>
- Bevelhimer, M.; Colby, J.; Adonizio, M.; Tomichek, C.; Scherelis, C. (2016). Informing a Tidal Turbine Strike Probability Model through Characterization of Fish Behavioral Response using Multibeam Sonar Output. Report by Oak Ridge National Laboratory (ORNL). pp 75.
- Melvin, G.; Cochrane, N. (2015). Multibeam Acoustic Detection of Fish and Water Column Targets at High-Flow Sites. *Estuaries and Coasts*, 38(1), 227-240.

- ORPC Maine (2014). Cobscook Bay Tidal Energy Project: 2013 Environmental Monitoring Report. Report by Ocean Renewable Power Company (ORPC). pp 502.
- Hastie, G. (2013). Tracking Marine Mammals Around Marine Renewable Energy Devices Using Active Sonar. Report by SMRU Consulting. pp 99.
- Parsons, Miles JG, et al. "Detection of sharks with the Gemini imaging sonar." *Acoustics Australia* 42.3 (2014): 185-190.
- Parsons, Miles JG, et al. "Imaging marine fauna with a Tritech Gemini 720i sonar." *Acoustics Australia* 45.1 (2017): 41-49.
- Lieber, Lilian & Williamson, Benjamin & Jones, Catherine & Noble, Leslie & Brierley, Andrew & Miller, Peter & Scott, Beth. (2014). INTRODUCING NOVEL USES OF MULTIBEAM SONAR TO STUDY BASKING SHARKS IN THE LIGHT OF MARINE RENEWABLE ENERGY EXTRACTION.
- E. Cotter and B. Polagye. Automatic Classification of Biological Targets in a Tidal Channel using a Multibeam Sonar. In prep.
- Cotter, E., Murphy, P., and Polagye, B. (2017) Benchmarking sensor fusion capabilities of an integrated instrumentation package, *International Journal of Marine Energy*, doi: 10.1016/j.ijome.2017.09.003.
- Cotter, E.; Murphy, P.; Bassett, C.; Williamson, B.; Polagye, B. (2019). Acoustic characterization of sensors used for marine environmental monitoring. *Marine Pollution Bulletin*, 144, 205-215.